

GT TOUCH, 2 INSULATED BOWLS AND TOUCH SCREEN



GT TOUCH, 2 INSULATED BOWLS AND TOUCH SCREEN

**Ref: 561076
(GT2T)**

GT TOUCH 2 STD 230/50 BLACK - GAS R290

General Features

GT TOUCH 2 is equipped with n. 2 I-Tank insulated bowls, 5 litres each, and can dispense up to 5 products: soft ice-cream, frozen yogurt, chilled coffee cream, sherbet or slush.

GT TOUCH 2 is easy to use, you can select between 5 products to dispense, or thanks to its exclusive interactive software you can set the desired temperature and auger speed.

GT TOUCH provides maximum flexibility, allowing to deliver the most appropriate product according to the time of the day, to the customer type and to the season.

The software is available in English and Italian language, but it is possible request for other languages.

The GT TOUCH 2 is equipped with n. 2 I-Tank™ insulated tank, with a capacity of 5 litres, which reduces the impact of the external temperature on the product, improving the cooling efficiency of the equipment, and saving energy and money.

Tanks work independently and each one has its own touch screen control panel.

GT TOUCH is suitable for merchandising actions: it is possible to customize the graphics on the frontal panel, lid and on the back (subject to negotiation).

GT TOUCH comes in black or white plastics with stainless steel finishing.

GT TOUCH guarantees high overrun which means a high return on investment.

SPM

GT TOUCH, 2 INSULATED BOWLS AND TOUCH SCREEN

Specifications

- Compact countertop machine which dispenses up to 5 different products: soft serve ice cream, frozen yogurt, cold creams, granitas and sorbets.
- GT Touch dispenses up to 5 products and is easy to use, thanks to the exclusive interactive touch screen, and to the software developed by the SPM Drink Systems R&D Department.
- Electronics, design and technology combined in a single machine.
- The standard I-Tank™ Technology increases the cooling power of the machine, by saving energy and money, and reduces condensation on the bowl's outer side, thus improving the product's aesthetics. Tanks work independently.
- It works with water- or milk-based powder products for ice cream, slush, cream, sherbet, or with ready to use mixed product base.
- Menu is available in Italian and English, but other languages can be programmed as well.
- Safety stop system.
- Lockable lid
- High overrun
- The excellent quality/price ratio is further enhanced by the significant overrun of the final product.
- It comes in black or white plastics with stainless steel finish
- It is possible to customize the graphics on the lid and on the back (subject to negotiation).

Construction

- Intuitive touch screen to select the products to dispense and set the desired options.
- The patented I-Tank insulated bowl reduces the impact of ambient temperature on the product, improving its cooling efficiency and guaranteeing energy and cost savings.
- Bowls work independently, and thanks to this is it possible to dispense different product with the one equipment at the same time
- Equipped with n. 2 I-Tank insulated tanks of 5 litres each.

GT TOUCH, 2 INSULATED BOWLS AND TOUCH SCREEN

Electric

Supply voltage:	220-240 V / 1 ph / 50 Hz
Electrical power max.:	0.6 kW
Current consumption:	3.2 Amps
Plug type:	CE-SCHUKO

Key Information:

Number of bowls:	2
Bowl's capacity:	5 lt
Control board:	
Dimensions, Width:	450 mm
Dimensions, Depth:	435 mm
Dimensions, Height:	650 mm
Net weight:	46 kg
Cooling system:	AIR

Refrigeration Data

Refrigerant gas:	R290
Sustainability	
Current consumption:	
561076 (GT2T)	3.2 Amps

Certifications



The company reserves the right to make modifications to the products without prior notice. All information correct at time of printing.

2024.05.17

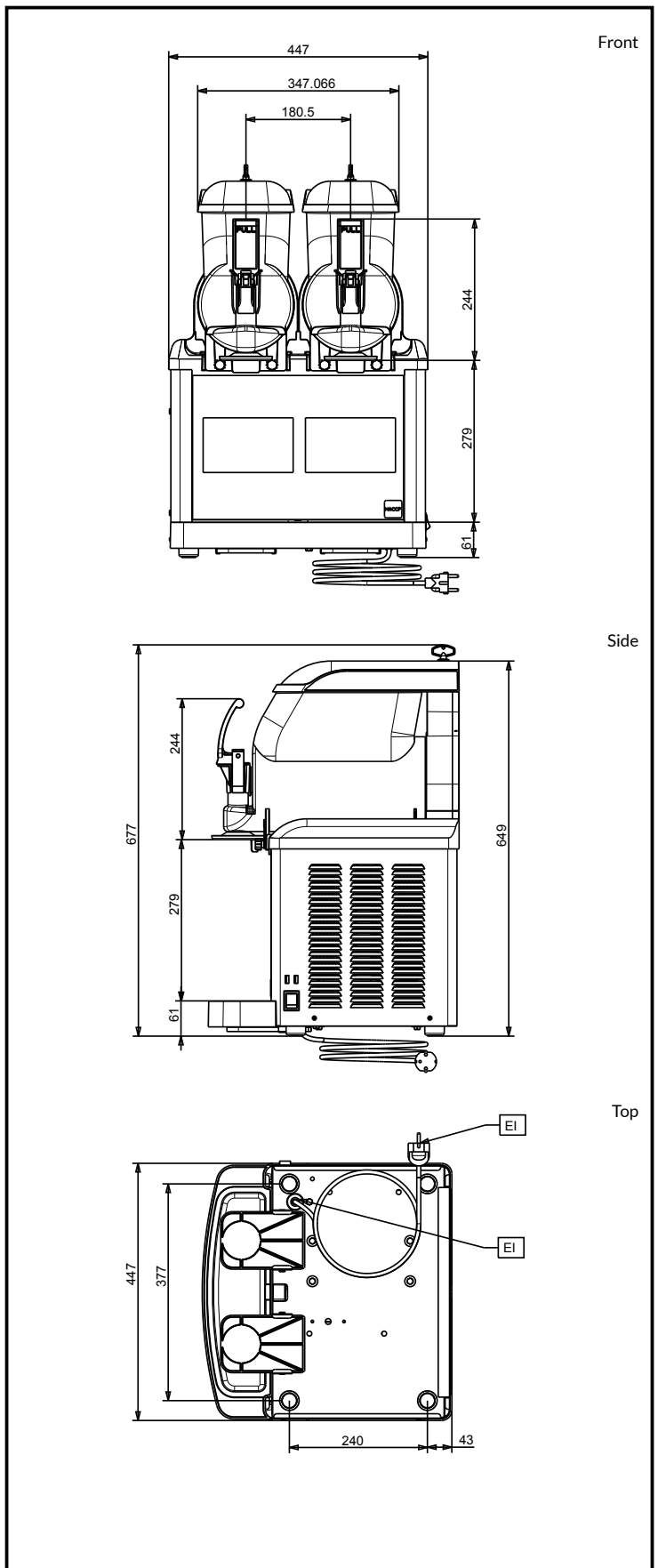

SPM

www.spm.drink-systems.com
infospm@electroluxprofessional.com